

**THORN
LIGHTING
LTD.**

**COMPREHENSIVE
LIGHTING
CATALOGUE
1971/72**



atlas & mazda

Standard Incandescent lamps

Introduction

The the brand-name Atlas is normally used for lamps used for commercial and industrial purposes and that of Mazda for those intended for domestic use. In this catalogue the appropriate brand-name is shown in the page heading in every case.

Index

- 5:2 **Atlas General Lighting Service Lamps**
(15-1500W and Extra low voltage)
- 5:3 **Mazda Home lighting lamps**
(Plus lamps, Netabulb, Pink Pearl, Nightlight.)
- 5:4 **Mazda Decorative and Coloured Lamps**
(Plain, Pink Pearl, Twisted, Coloured; Tipped, Twisted and Twilite Candle lamps; 45mm Round Bulb and Festive Round Bulb lamps)
- 5:5 **Mazda Decorative and Coloured Lamps**
(Decor and Decor Cone; 100mm Round Bulb; Decor fitting; Gala lighting set)
- 5:6 **Mazda Tubular Lamps**
(Architectural curved and straight, Double-cap striplites and single-cap tubular lamps)
- 5:7 **Atlas Special Service Lamps**
(Rough Service, Shatter-proof, Traffic Signal, Infra-red reflector, hard glass reflector and round bulb.)
- 5:8 **Atlas Reflector Lamps**
(Interior Display, Chelsea, High Bay and 100W crown silvered)
- 5:9 **Atlas Sealed Beam Reflector Lamps**
(PAR 38 100W & 150W. Plain, coloured, color-ray and cool-ray and PAR 56 300W.)
- 5:10 **Atlas Low-voltage Display Lamps**
(M Tungsten-halogen, 50W crown silvered, 50W mushroom, 50W clear 24W Miniature 150W crown silvered)
- 5:11 **Atlas Tungsten Halogen floodlighting lamps**
(M miniature; 300, 500, 750, 1000, 1500, 2000W Tubular)
- 5:12 **Atlas Floodlighting lamps**
(Class B1 100-1000W, Class B2, 500—2000W)
- 5:13 **Mazda Decoration sets**
(Fairy-lites, Festive-lites, Satin-lite, Fireflies, Jack Frost)
- 5:14 Lamp Cap Code

Special Notice

Where lamps are catalogued with a dual voltage rating, the electrical characteristics shown are those applicable at the filament design point, details of which are available on application.

atlas

General lighting service lamps

SINGLE COIL – High and low voltage

Watts	Standard Pack	Cap	Finish
15	25	BC, ES	Pearl
25	25	BC, ES	Pearl
40	25	BC, ES	Pearl or Clear
60	25	BC, ES	Pearl or Clear
75	25	BC, ES	Pearl or Clear
100	25	BC, ES	Pearl or Clear
150	25	BC, ES	Pearl or Clear
200	25	ES, BC	Pearl or Clear
300	24 & 12	GES	Clear
500	24 & 12	GES	Clear
750	12	GES	Clear
1000	12	GES	Clear
1500	6	GES	Clear

Voltages: 110, 120, 200/210, 220/230, 240, 250
 75W – 240/250 only; 1500W – 200/210, 220/230, 240, 250 only

SINGLE COIL – Extra low voltage

Watts	Standard Pack	Cap	Finish
15	25	BC, ES	Pearl
25	25	BC, ES	Pearl
40	25	BC, ES	Pearl
60	25	BC, ES	Pearl
100	25	BC, ES	Pearl

Voltages: 25/100W – 25, 50
 150/500W – 50 only

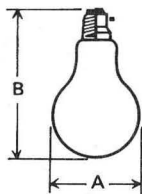

SINGLE COIL

	A	B
25–100W BC	60	105
150–200W BC	80	160

For ES caps add 1.5mm to length

All dimensions in mm.

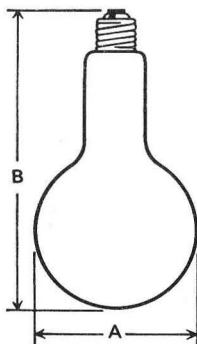

	A	B
300W & 500W GES	110	233
750W & 1000W GES	150	300
1500W GES	170	335

mazda

Home lighting lamps

Plus lamps – High efficiency coiled coil.

Watts	Cap	Finish	Std. Pack
40	BC, ES	Pearl	25
60	BC, ES	Pearl	25
100	BC, ES	Pearl	25
150	BC ES	Pearl	25

Voltagcs : 220/210, 220/230, 240, 250

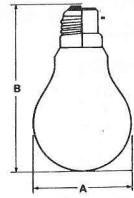

COILED COIL

	A	B
40–100W	60	105
150W (Coiled Coil)	68	125

Netabulb – Coiled coil in mushroom shaped bulbs.

Watts	Cap	Finish	Std. Pack
40	BC	Silverlight	25
60	BC	Silverlight	25
100	BC	Silverlight	25
150	BC	Silverlight	25
150	BC	Pearl	25

Voltagcs : 200/230, 240/250

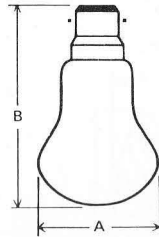

NETABULB

	A	B
40W	60	100
60W	60	100
100W	60	100
150W	75	120

Pink Pearl – Single coil pearl bulbs with an external light pink ceramic coating.

Watts	Cap	Finish	Std. Pack
40	BC	Pink	25
60	BC	Pink	25
100	BC	Pink	25
150	BC	Pink	25

Voltagcs : 240/250

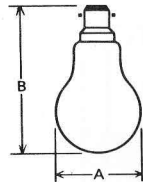

PINK PEARL (GLS)

	A	B
40 & 60W	60	105
100W	68	125
150W	80	160

Nightlight – Long life, low consumption, For children's or invalids' bedrooms and similar.

Watts	Cap	Finish	Std. Pack
5-8	BC	Pearl	50

Voltagcs : 200/250

5-10 way display packs per container

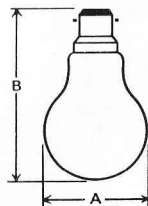

NIGHTLIGHT

	A	B
5–8W	60	105

All dimensions in mm

mazda

Decorative and coloured lamps

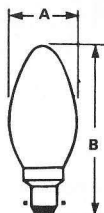

PLAIN CANDLE

	A	B
25W-40W BC	35	92
SBC	35	98
SES	35	99
60W BC	45	123
SBC	45	128

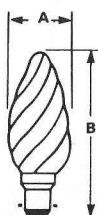

COLOURED PLAIN CANDLE

Watts	Volts	Diameter	Cap	Finish	Standard pack
25	240/250	35	BC only	Amber	50
40	240/250	35	BC only	Amber	50
60	240/250	45	BC only	Amber	50

*SES Cap in Silverlight only

TWISTED CANDLE

	A	B
25W BC	35	95
SBC	35	99
40W-60W BC	46	123
SBC	46	128

PINK PEARL CANDLE

Watts	Volts	Diameter	Cap	Finish	Standard pack
40	240/250	35	BC, SBC	} Pearl bulbs with an internal light pink diffuse coating	50
60	240/250	45	BC, SBC		50

TWISTED CANDLE

Watts	Volts	Diameter	Cap	Finish	Standard pack
25	240/250	35	BC, SBC	Clear, Frosted	50
40	240/250	46	BC, SBC	Clear, Frosted	50
60	240/250	46	BC, SBC	Clear, Frosted	50

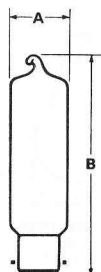

TWILITE CANDLE

	A	B
BC	30	125
SBC	30	131

COLOURED AND TIPPED TWISTED CANDLE

Watts	Volts	Diameter	Cap	Finish	Standard pack
40	240/250	46	BC only	Amber, Amber tip Pink, Pink tip	50
60	240/250	46	BC only	Amber, Amber tip Pink, Pink tip	50

5 x 10-way packs per container

TWILITE CANDLE

Watts	Volts	Diameter	Cap	Finish	Standard pack
40	240/250	30	BC, SBC	Frosted	50

ROUND BULB

Watts	Volts	Diameter	Cap	Finish	Standard pack
25	240/250	45	BC, SBC, SES	Silverlight	50
40	240/250	45	BC, SBC, SES	Silverlight	50

5 x 10-way packs per container

ROUND BULB

	A	B
BC	45	65
SBC	45	70
SES	45	74

ROUND BULB FESTIVE

Watts	Volts	Diameter	Cap	Finish	Standard pack
15	200/250	45	BC, ES	Amber, blue, green, red, white, yellow	50
25	200/250	45	BC, ES	Amber, blue, green, red, white, yellow	50

5 x 10-way packs per container

All dimensions in mm.

mazda

Decorative and coloured lamps

40W DECOR LAMP

Watts	Volts	Standard pack	Cap	Finish
40	240/250	25	BC	Silverlight

60W DECOR LAMP

60	240/250	10	BC	Silverlight
----	---------	----	----	-------------

100W DECOR LAMP

100	240/250	10	BC	Silverlight
-----	---------	----	----	-------------

60W DECOR CONE LAMP

60	240/250	25	BC	Silverlight
----	---------	----	----	-------------

40, 60 & 100W DECOR

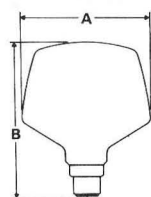

	A	B
40W Decor	77	100
60W Decor	97	120
100W Decor	97	120
60W Decor Cone	60	158

60W DECOR CONE

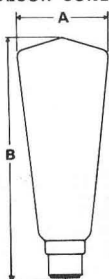

40W ROUND BULB

40 DECOR	240/250	10	BC, ES	Silverlight
----------	---------	----	--------	-------------

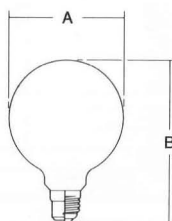

ROUND BULB

	A	B
BC	100	139
ES	100	140

INTERNALLY COLOURED GLS

15	200/250	25	BC, ES	Amber, blue, green, pink, red, white, yellow
25	200/250	25	BC, ES	Amber, blue, green, pink, red, white, yellow
40	200/250	25	BC	Amber, blue, green, pink, red, yellow
60†	200/250	25	BC	Amber, blue, green, pink, red, yellow

†Not suitable for use outdoors unless enclosed for protection against rain.

DECOR FITTING AND LAMP

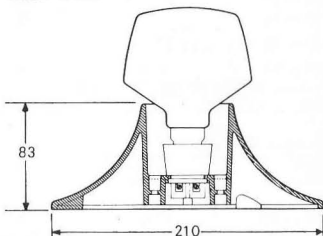

GALA LIGHTING SET

A string of 12 waterproof lampholders for gala lamps.
Catalogue No. AME 1809 Lamp Reference No. 30-9995

GALA LIGHTING SET LAMPS comprising the following

25	200/250	2 of each	BC	Pink, yellow, amber red, green, blue
----	---------	-----------	----	--------------------------------------

INTERNALLY COLOURED AND GALA

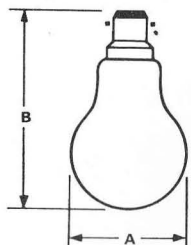

	A	B
15W, 25W	60	105
40W & 60W	60	105

All dimensions in mm

mazda

Tubular lamps

Architectural curved — $\frac{1}{8}$, $\frac{1}{4}$, $\frac{1}{2}$ circle.

Watts	Length	Std. Pack	Finish
60	—	1	Opal
Voltage: 240/250		Tube diameter	
Caps: Peg		30mm.	

Architectural straight

Watts	Length mm	Std. Pack	Finish
35	305	25	Opal
53	457	1	Opal
60	500	1	Opal
60	500	10	Opal Double Centre contact
75	610	1	Opal
110	915	1	Opal
150†	1220	1	Opal
Voltage: 200/230, 240/250		Tube diameter	‡240/250v only
Caps: Peg		25 mm.	

Double cap — Tubular Striplites

Watts	Length	Std. Pack	Finish
30 or 60	221 mm	25	Clear
30 or 60	284 mm	25	Clear
30 or 60	221 mm	25	Opalised
30 or 60	284 mm	25	Opalised
30 or 60	221 mm	25	Frosted
30 or 60	284 mm	25	Amber
Voltage: 200/230, 240/250		Tube Diameter	
Caps: Centre contact		25mm	

Single Tubular

Watts	Diameter	Std. Pack	Finish
25 or 40	25mm	50	Clear
25	25mm	50	Frosted
40 or 60	37mm	25	Opal (Long-Lite)
Voltage: 25w — 110, 200/230, 240/250 40w — 240/250v only			
Caps: B.C., S.B.C., E.S., S.E.S.			
Voltage: 60w — 200/230, 240/250			
Cap: B.C.			
Voltage: 25w Clear — 110, 120, 200/230, 240/250			
Remainder 240/250w only			

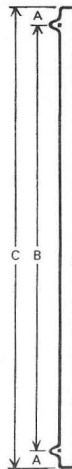

ARCHITECTURAL

	A	B	C
12 inch 35w	30	229	305
18 inch 53w	30	382	457
20 inch 60w	30	424	500*
24 inch 75w	30	534	610
36 inch 110w	30	839	915
48 inch 150w	30	1144	1220

*Available with Peg Contacts or Double Centre Contact.

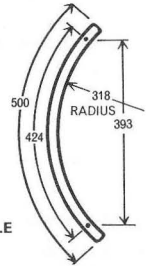

$\frac{1}{2}$ CIRCLE

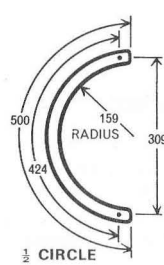

$\frac{1}{2}$ CIRCLE

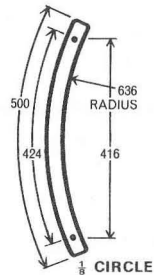

$\frac{1}{2}$ CIRCLE

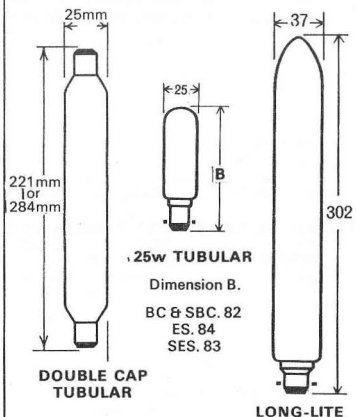

All dimensions in mm

ROUGH SERVICE – These lamps have additional filament supports and are for use in portable handlamps and similar locations

Watts	Standard Pack	Cap	Finish
25	25	BC	Pearl
40	25	BC, ES	Pearl
60	25	BC, ES	Pearl
100	25	BC, ES	Pearl

Voltages: 40/100W – 110, 120, 200/250; 25W – 200/250

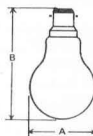

ROUGH SERVICE

	A	B
25, 40 & 60W	60	105
100W	68	125

SHATTERPROOF – ROUGH SERVICE. This lamp has a special coating to contain the glass fragments in the event of breakage.

Watts	Standard Pack	Cap	Finish
100	25	BC, ES	Pearl – Lacquered

Voltage: 200/250

SHATTERPROOF

	A	B
100W	68	125

TRAFFIC SIGNAL – For use in traffic signals

Watts	Standard Pack	Cap	Finish
65	25	ES, BC	Clear
50	1	BiPin	Clear 12V Tungsten Halogen M32

Voltages: 65W in 240, 250V ES 250V only BC M32 in 12V only

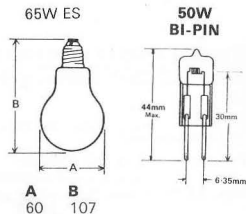

HEATING LAMPS

INFRA-RED REFLECTOR (Standard bulb)

Watts	Standard Pack	Cap	Finish
150	12	ES	Clear Front
275	12	ES, BC	Clear Front
275	12	ES, BC	Satin Front
275	12	ES, BC	Red Front

Voltages: 100/130, 200/250

INFRA-RED REFLECTOR

	A	B
150W	126	178
275W	126	178

INFRA-RED REFLECTOR (Hard glass bulb)

Watts	Standard Pack	Cap	Finish
275	12	ES, BC	Clear Front
275	12	ES, BC	Red Front

Voltages: 200/250 only

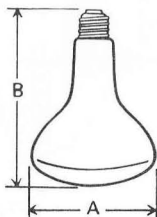

INFRA-RED ROUND BULB

Watts	Standard Pack	Cap	Finish
250	25	ES	Pearl

Voltages: 100/130, 200/250

INFRA-RED ROUND BULB

	A	B
250W ES	88	180

Note: A Range of Linear Quartz Infra Red Lamps is available. Details on request.

atlas

Reflector lamps

INTERIOR DISPLAY REFLECTOR LAMPS

Type	Watts	Standard Pack
Reflector Display	75	10
Reflector Display – Lacquered – Red	75	10
Reflector Display – Lacquered – Blue	75	10
Reflector Display – Lacquered – Green	75	10
Reflector Display – Lacquered – Yellow	75	10
Reflector Display	100	10
Reflector Display	150	10

REFLECTOR DISPLAY

	A	B
75W	95	135
100W	95	135
150W	126	178

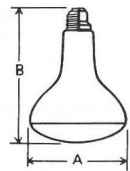

REFLECTOR SPOTLIGHT AND FLOODLIGHT

	A	B
250W	126	178

For Chelsea Fittings

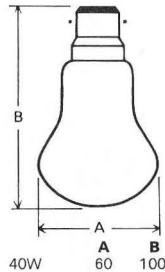

	A	B
40W	60	100

INTERIOR DISPLAY SPOTLIGHTS AND FLOODLIGHT

For display areas and interior floodlighting

Type	Watts	Standard pack
Spotlight	250	10
For Chelsea Glass*	40	25

Voltages: 110, 200/230, 240/250

*110V Chelsea not available 200/230, 240/250V BC. only

Caps: ES, BC. Except 250W which is ES only.

Life:— 1000 hours

HIGH BAY REFLECTOR

Watts	Cap	Standard Pack
500	GES	6

Voltages: 240, 250

Life:— 1000 hours

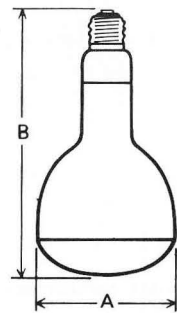

500 WATT REFLECTOR FLOODLIGHT

	A	B
500W E40/45	165	312

MAINS VOLTAGE DISPLAY LAMP

For use in Atlas fitting VM100

Voltage: 240/250

Life:—1000 hours

Type	Watts	Cap	Std. Pack
Crown		ES	
silvered	100	3 pin BC 25	

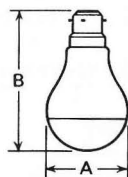

100W DISPLAY LAMP

	A	B
100W 3-pin BC: ES	68	125

All dimensions in mm

atlas

Sealed Beam reflector lamps

PAR 38 SEALED BEAM

For outdoor and indoor application

Type 100W	Standard Pack
Clear Spotlight	10
Clear Floodlight	10
Lacquered – Red	10
Lacquered – Yellow	10
Lacquered – Blue	10
Lacquered – Green	10

Voltages: Lacquered 240/250 only
Others 200/230, 240/250

Cap: ES. Life:— 1500 hours

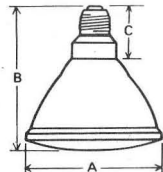

SEALED BEAM REFLECTOR FLOODLIGHT AND SPOTLIGHT

	A	B	C
100W & 150W	121.5	135	51

Type 150W	Standard Pack
Clear Spotlight	10
Clear Floodlight	10
Clear Floodlight – 24V	10
Color-Ray Spot – Red	10
Color-Ray Spot – Yellow	10
Color-Ray Spot – Blue	10
Color-Ray Spot – Green	10
Cool-Ray Spotlight	10

Voltages: Color-Ray and Cool-Ray 240/250 only
Others 110/120, 200/230, 240/250 (except 24V flood)

Cap: ES. Life:— 2000 hours

PAR 56 SEALED BEAM

For outdoor and indoor application

Type 300W	Standard pack
Clear – Narrow Spot	10
Clear – Medium	10
Clear – Wide	10

Voltages: 200/230: 240/250

Cap: GX16d Life:— 2000 hours

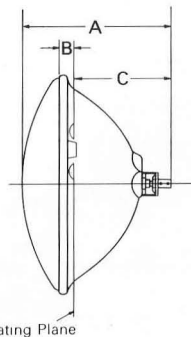

A	B	C
133.4	11.7-13.7	85

PAR SEALED BEAM SPOTLIGHT AND FLOODLIGHTS

These lamps, with the exception of the Cool-Ray lamp, are for indoor and outdoor applications. The Color-Ray spotlights have internal thin film dichroic lenses which have a high transmission factor and maintain constant colour through life. The Cool-Ray lamp has a dichroic reflector, allowing

much of the heat to pass through the back of the lamp without loss of light. This lamp is for use in special fittings only, indoors. Its primary use is for the illumination of food displays, including meat and fish.

All dimensions in mm

atlas

Low Voltage Display Lamps

Illus.	Volts	Watts	Lamp Ref. No.	Std. Pack	Type
1	12	50	11-8015	1	The compact tungsten halogen lamp M32 has been developed for use in the low voltage display lighting fitting. This lamp has all the advantages of tungsten halogen lamps with a long life of 2,000 hours, high efficiency and nearly 100% lumen maintenance.

Cap
Bi-pin

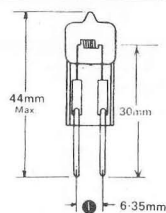

2	12	50	11-7015	25	The 38mm lamp is spherical in shape. It is internally crown silvered and gives a non-spill narrow beam of light.
---	----	----	---------	----	--

Bosch

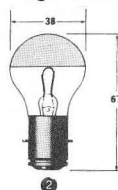

3	12	50	11-8012	25	The mushroom-shaped 64mm sealed beam lamp with Bosch cap is internally silvered with a diffusing front face and gives a soft edge beam of high intensity.
---	----	----	---------	----	---

Bosch

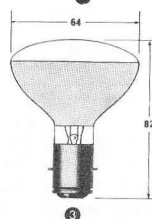

4	12	50	11-7014	25	The 12V 50W lamp has a clear front, and an internal reflector aluminised to the parabolic bulb. This gives a narrow beam of light.
---	----	----	---------	----	--

E.S.

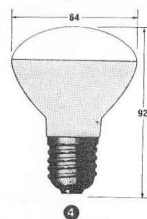

5	12	24	11-7005	25	The 12V 24W lamp gives a high intensity soft edged beam. Internal Reflector Diffusing Front.
---	----	----	---------	----	--

S.B.C.



6	24	150	11-7040	12	Crown Silvered Clear Back
---	----	-----	---------	----	---------------------------

Bosch

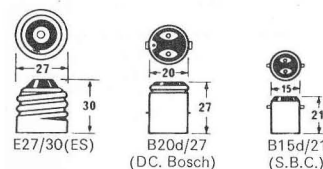
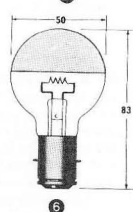

A transformer is normally required for the operation of these lamps.

The 12V lamps have a nominal life of 1,000 hours (except M32 which has a rated life of 2,000 hours), whilst the 24V 150W lamp has been designed to give a life of 500 hours.

All dimensions in mm

atlas Tungsten Halogen lamps

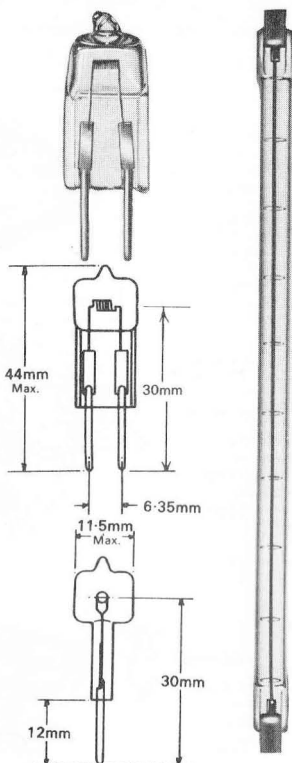

A new and powerful light source in the range of tungsten filament lamps.

APPLICATION – General illumination floodlighting and display lighting.

RANGE: six linear lamps – 300W, 500W, 750W, 1000W, 1500W, 2000W.

COMPACT SPOTLAMP – 12V, 50W
For display lighting and new-type traffic signals.

RATED LIFE – 2000 hours.

CONTROL GEAR – None required.

OPERATING POSITIONS – Linears horizontal $\pm 4^\circ$. Single ended lamp – Universal.

PRINCIPLE – The tungsten filament is enclosed in a gas filled quartz tube, together with a carefully controlled quantity of a halogen. When the tungsten filament is heated by the electric current the halogen vaporises and controls the evaporation of the filament; the tungsten vapour being carried to the contrastingly comparative cool wall of the bulb where it combines with the halogen to form a tungsten halide. This compound then returns to the filament where it is chemically converted back to tungsten and the halogen and the action continues to repeat itself while the lamp is in operation.

The regenerative cycle performs a 'self-cleaning' action on the inner surface of the bulb resulting in nearly 100% lumen maintenance.

ADVANTAGES

- 1 Up to 20% more light output compared to corresponding GLS lamp.
- 2 Double life – 2000 hours.
- 3 Constant light output through life.
- 4 Compact, easily controllable light source.

Nom. watts	Voltage	Nom. lumens At rated voltage	Rated life hours	Nom. colour temp. °K	Overall lamp length Dimensions in millimetres	Bulb diam.	Nom. lighted length	Type of contacts	Burning position	Catalogue No.
50**	12	900	2000	3000	44 max	11.5 max.	3.5 x 2.5	Single ended bi-pin	Universal	M32
300	200/230 240/250	5000	2000	2850	117 ± 0.25	8.0 +0.5 -0.25	65	R7s	To within 4° of horizontal	THD/300/voltage rating
500	110	10500	2000	3000	117 ± 2.5	10 ± 0.25	60	R7s†	to within 4° of horizontal	THD/500/110
500	120	10500	2000	3000	117 ± 2.5	10 ± 0.25	60			THD/500/120
500	200/230 240/250	9500	2000	2850	117 ± 2.5	10 ± 0.25	70			THD/500/voltage rating
750*		15000	2000	2900	189 ± 2.5	10 ± 0.25	130			THD/750/voltage rating*
1000†	240/250	21000	2000	3000	189 ± 2.5	10 ± 0.25	140	R7s	To within 4° of horizontal	THD/1000/voltage rating
1500		33000	2000	3000	254 ± 2.5	10 ± 0.25	200			THD/1500/voltage rating
2000	*240/250	44000	2000	3000	333 max.	11 max.	250	R7s	To within 4° of horizontal	THD/2000/voltage rating

NOTES

All lamps with the exception of the M32 are fitted with an internal fuse. It is an advantage to have an additional fuse in the fitting or external circuit. During operation, the temperature of the lamp pinch seal should not exceed 350°C, whilst

the bulb wall temperature must not drop below 250°C in order to maintain the tungsten halogen cycle.

*The Standard length of the 750W lamp is 189mm.

Lamps with an overall length of 178mm are also available.

Please specify length when ordering.

†The 1000W lamp is also available in 110V rating.

‡Double-ended lamp with ceramic end-caps and recessed contacts (R7s). For distance between contacts deduct 4mm from overall length.

**Spotlight or Traffic Signal Lamp.

atlas

Floodlighting lamps

CLASS B1 (Spherical bulbs)

For floodlighting of buildings and for studio and theatre spots and floodlights.

The objective average life in well-ventilated fittings is 800 hours.

The burning position is within 135° from cap down.

Reference No.	Watts	Standard Pack	Finish
B1/1	100	12	Clear
B1/2	250	12	Clear
B1/3	500	12	Clear
B1/4	1000	12	Clear

Reference No.	Cap	Lumens at 100/110/115V	Lumens at 200/250V*
B1/1	ES	1100	900
B1/2	ES	3600	3100
B1/3	GES	8000	7250
B1/4	GES	18000	16500

*Lamps available in 10V steps

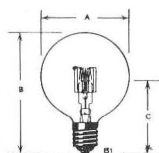

TYPE	A (max)	B (max)	C (nom)
B1/1	82	125	75
B1/2	132	190	115
B1/3			
B1/4			

CLASS B2 (GLS bulbs)

Applications are similar to Class B1 especially floodlighting from high towers for football grounds, stadiums, tattoos and similar. The average objective life for lamps B2/1-3 is 800 hours in well-ventilated fittings.

For B2/4 it is 200 hours which is very adequate for a full season of evening matches.

Reference No.	Watts	Standard pack	Finish
B2/1	500	9	Clear
B2/2	1000	6	Clear
B2/3	1500	6	Clear
B2/4	2000	6	Clear

Reference No.	Cap	Lumens at 100/110/115V	Lumens at 200-250V*
B2/1	GES	8000	7250
B2/2	GES	18000	16500
B2/3	GES	—	26000
B2/4	LPF - P40/412	—	42000

*Lamps available in 10V steps

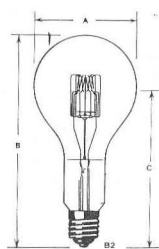

TYPE	A (max)	B (max)	C (nom)
B2/1	132	275	202
B2/2	152	309	225
B2/3	172	344	250
B2/4	172	344	207



All dimensions in mm

mazda

Decoration sets and spare lamps

Decoration sets for 200/250v operation



Fairy-Lites

The ever-popular family favourite. Twelve gaily coloured Mazda lamps and a spare, with flex, holders and B.C. connector.

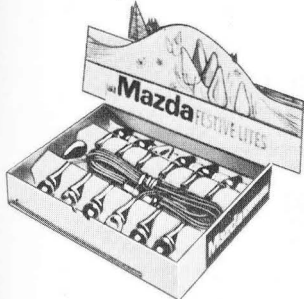

Festive-Lites

A colourful set with the sparkle of cut crystal. Twelve new coloured crystal coated lamps and a spare with flex, holders and B.C. connector.

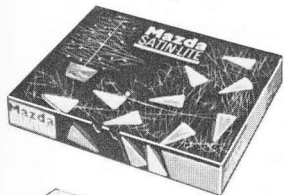

Satin-Lite

The soft, silky sheen of satin. Twelve coloured Mazda lamps plus a spare with flex, holders and B.C. connector.

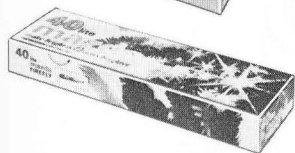

Firefly

Glowing 'pin-points' of colour add touches of brilliance and the atmosphere of a continental Fiesta. L.E.S. capped lamps.
 Twentylite sets:
 20 12v 1.2w lamps+a spare.
 Fortylite sets:
 40 6v 0.75w lamps+2 spares.



Jack Frost

An icy, brilliant sparkle with twelve frost coated coloured lamps and a spare plus flex and B.C. connector.



Regency

Tiny Regency lanterns to make your home glow like Brighton Pavilion. L.E.S. capped lamps plus a spare with flex, holders and BC connectors.
 Twentylite set:
 20 12v 1.2w lamps+a spare.

Spare lamps



Fairy-Lites

Three 20 volt 3 watt Mazda lamps of different colours for use in twelve lamp sets.



Festive-Lites

Three 20 volts 3 watt Mazda lamps in a bubble pack in various colours with a crystal finish. Suitable for replacement in Fairy-Lites sets.



Satin-Lite

Three 20 volt 3 watt Mazda lamps in various attractive satin finished colours.



Firefly

Bubble packs containing five different coloured Mazda lamps. 6 volt lamps for Fortylites sets and 12 volt lamps for Twentylites sets.



Jack Frost

Three 20 volt 3 watt Mazda lamps with frosted finish in different gay colours.

Lamp cap code

All dimensions in mm

LAMP CAP CODE

B.C. Bayonet

S.B.C. Small Bayonet

S.C.C. Small Centre Contact

E.S. Edison Screw

S.E.S. Small Edison Screw

M.E.S. Miniature Edison Screw

G.E.S. Goliath Edison Screw

The dimension code indicates, first, by letter, the type of cap. The first two figures indicate the nominal outer diameter of the cap barrel or screw thread in millimetres. The next two figures indicate the overall length and the last two, the diameter of the flange.

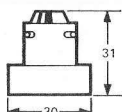

3-pin B.C.
B22d-3/31 x 30

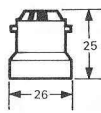

B.C.
B22d/25 x 26



S.C.C.
BA. 15s/21



S.C.C.
S15s/15

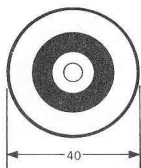
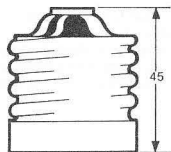

G.E.S.
E40/45



S.E.S.
E14/25 x 17

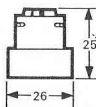

3-pin B.C.
B22d-3/25 x 26

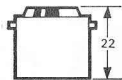

B.C.
B22/22



E.S. E 27/27

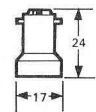

S.B.C.
B15/24 x 17

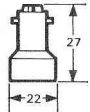

S.B.C.
B15/27 x 22

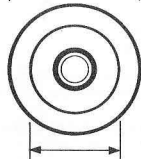
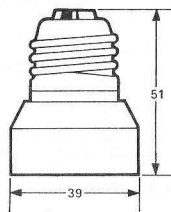

E.S.
E27/51 x 39



Candelabra
E12/21 x 13



S.E.S.
E14/23 x 15