

# Osram-GEC

## LIGHTING CATALOGUE

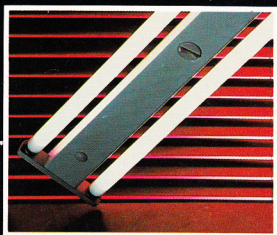
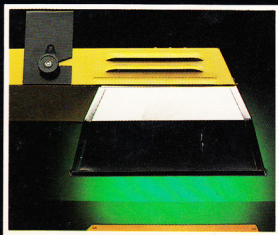
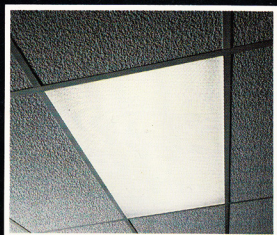
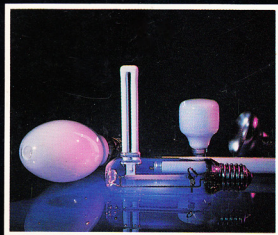

**LOOKING AT ENERGY SAVING  
IN A DIFFERENT LIGHT.**

# STANDARD CAPS

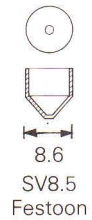
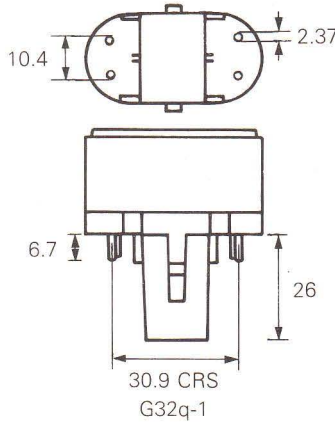
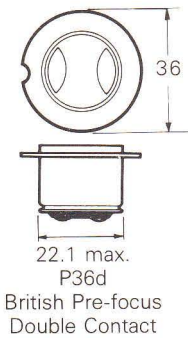
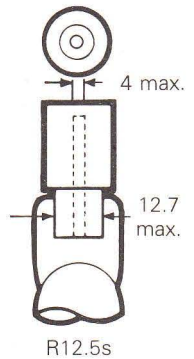
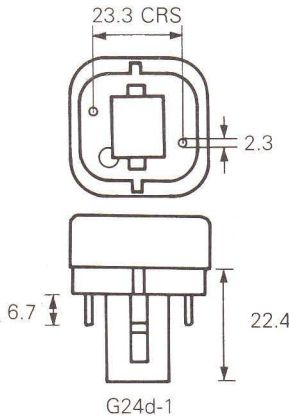
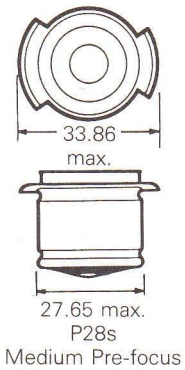
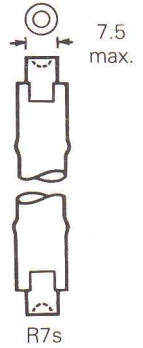
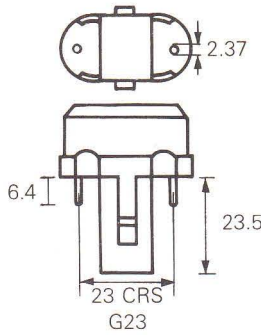
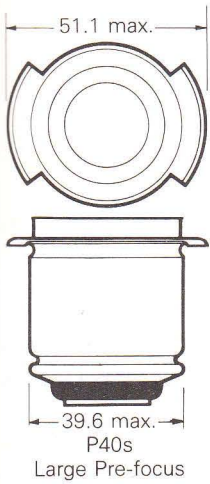

# STANDARD CAPS



22.15 max.  
B22d (BC)  
Bayonet Cap



22.15 max.  
B22d-3  
3 pin Bayonet Cap



15.3 max.  
BA15s (SCC)  
Small Centre Contact



15.25 max.  
B15d (SBC)  
Small Bayonet Cap



9.25 max.  
BA9s (MCC)  
Miniature Centre Contact



15.25 max.  
S15s  
Single Contact Cap  
for Striplite



15.25 max.  
BAY15d  
Bayonet Automobile

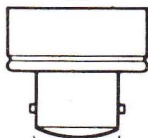
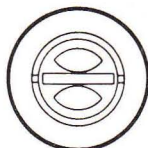

22 max.  
BY22d  
Sodium Bayonet Cap



7.1 max.  
BA7s  
Bayonet Automobile



20.10 max.  
BA20s  
Bosch



26.45 max.  
E27 (ES)  
Edison Screw



9.53 max.  
E10 (MES)  
Miniature Edison Screw

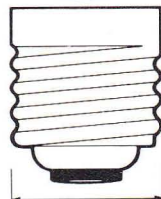
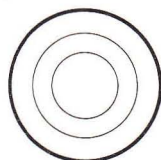

39.5 max.  
E40 (GES)  
Goliath Edison Screw



13.89 max.  
E14 (SES)  
Small Edison Screw



5.33 max.  
E5 (LES)  
Lilliput Edison Screw

# STANDARD CAPS

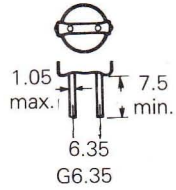
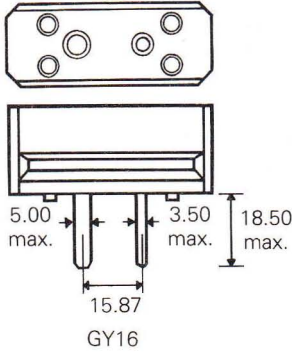
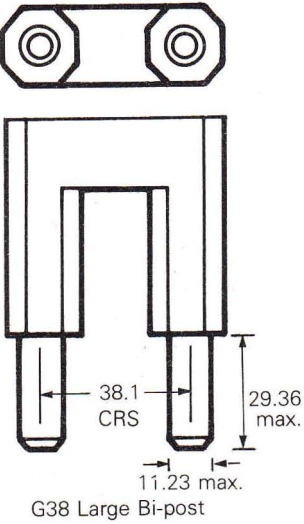

OTHER  
MEASUREMENTS  
AS G6.35

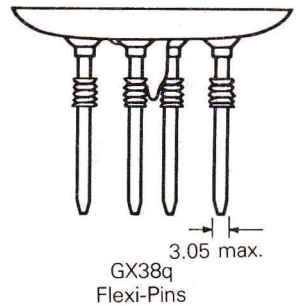
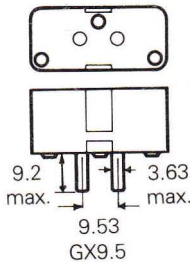
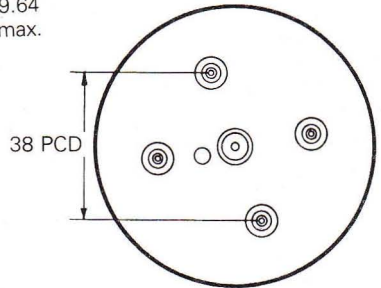
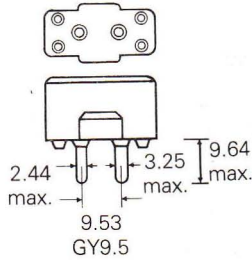
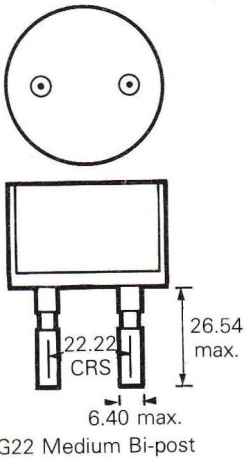
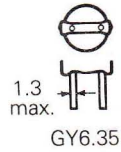

G13 Medium Bi-post